



# 75%

## ENERGY SAVINGS

Traditional HID lighting replacement

# Zorro 2

Reliable, efficient, built to last



The Zorro 2 continues the legacy of the Zorro area light, being robust and reliable. The Zorro 2 has improved efficacy and greater versatility providing quality illumination over 150 lumens per watt.

Comes in a wide range of power & light distribution options. Supremely efficient long life IP66 luminaire, ideal for any urban, industrial or residential application to light up pathways, streets, carparks & other similar areas.

The Zorro 2 offers both performance and ease of installation.



## OPTIONS AND BENEFITS

- **Easy to install & maintain** - Toolless clipping system
- **Expected life >110,000hrs @L70** from high quality high powered LEDs
- **High efficacy of >150 lm/w** using Lumileds LEDs
- **In-built surge protection** - 10kV
- **Control options** - PE Cell, 1-10V Dimmable, Casambi wireless controls
- **Mounting accessories** - Pole reducer, cross arm, adaptor & wall mount bracket
- **Available in black** and grey
- **IP66** - Ingress protection
- **IK10** - Impact rating
- **5 year warranty**

## APPLICATIONS



COUNCIL PARKS



BIKE PATHS



OUTDOOR CAR PARKS



INDUSTRIAL ESTATE



CAMPUSES UNIVERSITIES

## FEATURES



SAFETY COMPLIANCE



LOW MAINTENANCE



VERTICAL MOUNT



HORIZONTAL MOUNT



10kV SURGE PROTECTION



INGRESS PROTECTION



IMPACT RATING



YEAR WARRANTY

## PRODUCT RANGE

Model #	Rated Power (W)	Lumen Output (lm)	Dimensions L x W x H (mm)	Weight (kg)
ZAL15S-Tx-4K-B	15	2,400	610 x 190 x 143	4.7
ZAL40S-Tx-4K-B	40	6,400	610 x 190 x 143	4.7
ZAL60S-Tx-4K-B	60	8,900	610 x 190 x 143	4.7
ZAL80M-Tx-4K-B	80	12,800	660 x 240 x 143	5.8
ZAL120M-Tx-4K-B	120	18,600	660 x 240 x 143	5.8
ZAL150L-Tx-4K-B	150	23,900	762 x 290 x 143	8.1
ZAL200L-Tx-4K-B	200	29,900	762 x 290 x 143	8.1

x stands for lens type and can be 2, 3 or 4 for Type 2, Type 3 or Type 4 light distribution. B stands for Black coloured housing & can be replaced with G for Grey.

## TECHNICAL INFORMATION

### Optical

Light source	Lumileds LEDs
Lumen output	2,400 - 29,900 lumens
CRI	Ra>70
CCT	4000K standard 2200K - 5700K available on request
Luminaire efficacy	> 150 lm/W

### Electrical

Power consumption (W)	15, 40, 60, 80, 120, 150, 200
Operating frequency	50/60Hz
Operating voltage range	100 - 240V AC
Surge protection	10KV standard, 20KV available on request
Power factor	>0.9/240V AC at full load
Driver type	Inventronics
Driver efficiency	> 90%

### Environmental

IP rating	IP66
Impact rating	IK10
Weight	4.7 - 8.1kg
Ambient temperature range	-40°C to +50°C
Material Composition (body)	Powder coated die-cast aluminium
Glass cover	Tempered glass
Expected Lifespan	>110,000 hours @ L70

### Controls - Optional

Photoelectric (PE) cell  
Casambi wireless control.  
1-10V Dimming

### Accessories

Wall mounted bracket  
Pole mount adaptors

### Warranty\*

5 years

Data subject to change without notice  
\* Refer to warranty policy

## DIMENSIONS

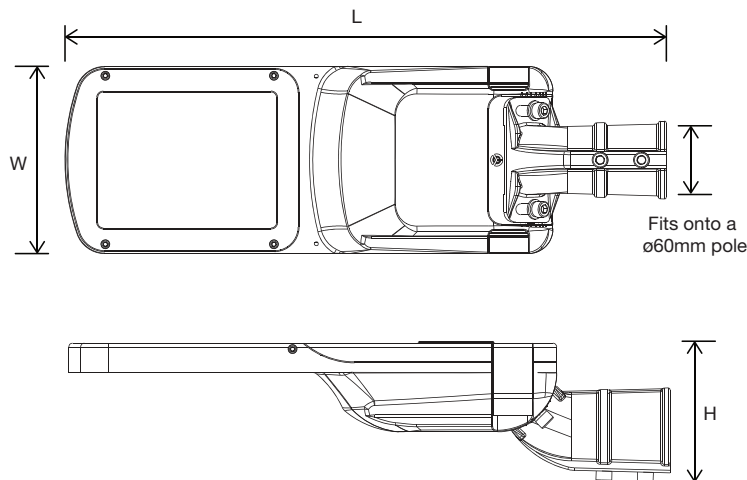

## PHOTOMETRICS

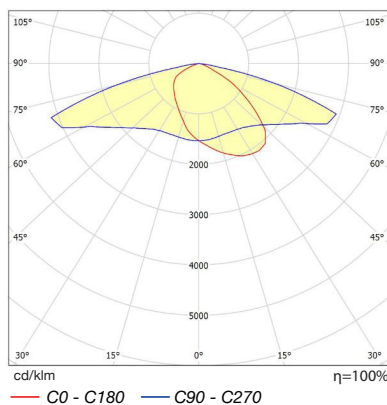

Type 2

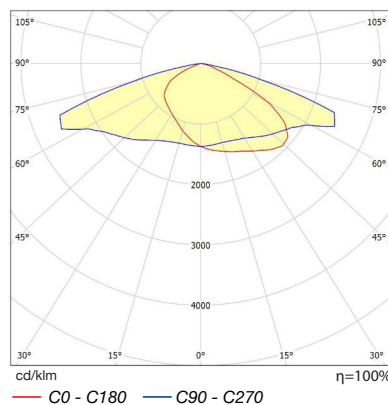

Type 3

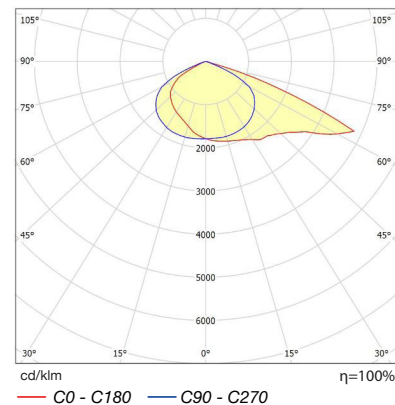

Type 4

## OPTIC SELECTION GUIDE

Lens	Distribution	Application	Area Covered In front of Pole	Area Covered Sideways
<b>Type 2</b>	Wide Street Side Throw & Narrow Forward Throw (Most commonly used for 15W models)	Narrow Pathways/Lanes/Roads	1.6x Pole Height	5.1x Pole Height
<b>Type 3</b>	Medium Street Side & Forward Throw (Most commonly used for models 40W and above)	Wider Pathways/Lanes/Roads; Carparks, Area Lighting	1.9x Pole Height	4.7x Pole Height
<b>Type 4</b>	Narrow Street Side Throw & Large Forward Throw	Large Area in front of pole	2.6x Pole Height	3.4x Pole Height

## INDICATIVE POLE HEIGHT GUIDE

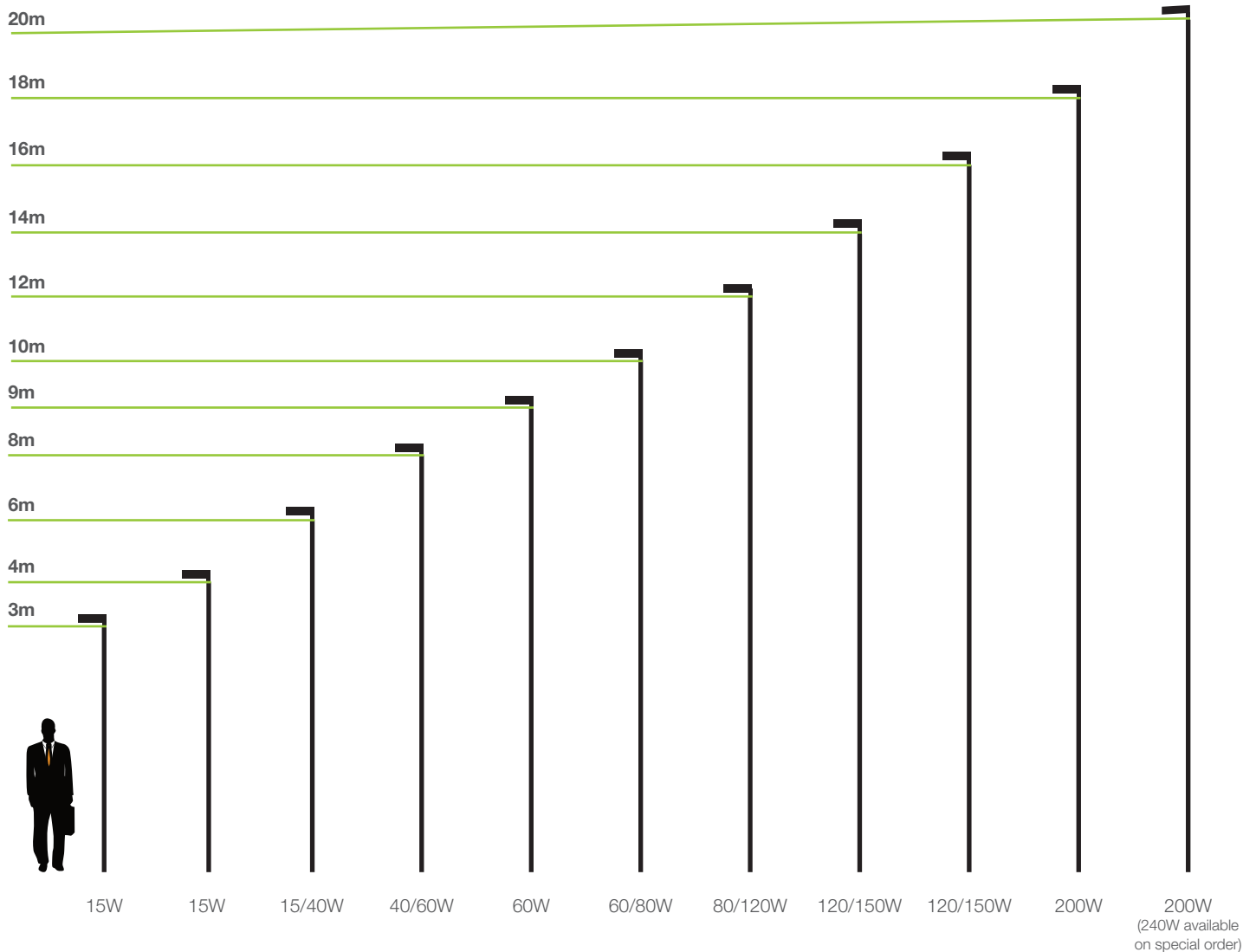

Indicative guide only.

Use higher wattages if:

- You need higher lux levels or
- The compliance requirement is higher than the lowest lighting standard

Request a lighting design for full compliance to the Australian Standards

## SMART CONTROLS

The Zorro 2 optional smart control solutions:

**Photoelectric (PE) sensors** integrated into the Zorro 2 light fitting enables automatic switching.

Get increased functionality and total lighting control with **Casambi wireless control**. The easy to commission wireless control technology is flexible, scalable and intelligent. Perfect for applications where additional lighting control features are required.

## MOUNTING

The Zorro 2 comes with a spigot/mounting bracket, which can be adjusted for horizontal or vertical mounting at angles shown below. The bracket is suitable to be mounted on a 60mm diameter pole or arm.

Adjustable tilt angle:  $\pm 0-5-10-15^\circ$

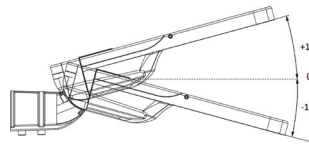

Horizontal installation

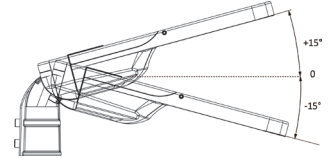

Vertical installation

## POLE MOUNT ADAPTORS & ACCESSORIES

Name	Part Number	Description
Pole Reducer	ZWB-PoleRed	Reduces pole diameter from 78mm to 60mm. Powder coated Q235 steel 3mm/7.5mm thickness, RAL9022
Cross Arm	ZWB-CrosArm	Perfect for two lights on one pole. Arm: 500mm x 60mm diameter. Fits 76mm diameter round pole. Powder coated Q235 steel, RAL9022
Connecting Adaptor	ZWB-ConAdapV2	Increase 42mm pole size to 60mm. Anodized aluminium, 4mm thickness
Wall Mounted Bracket	ZWB-15 Degree	Wall mounted bracket creating a 15° upward tilt. Galvanised hot dip 3mm/6mm thickness

## COMPLIANCE

The Zorro 2 series meets or exceeds all relevant standards and regulatory requirements.



For a full compliance and testing list visit [www.enlighten.com.au](http://www.enlighten.com.au). IES files, warranty, installation and product guides are also available for download.

Sold nationally through major electrical wholesalers.



Lighting Council  
AUSTRALIA  
MEMBER 2021