

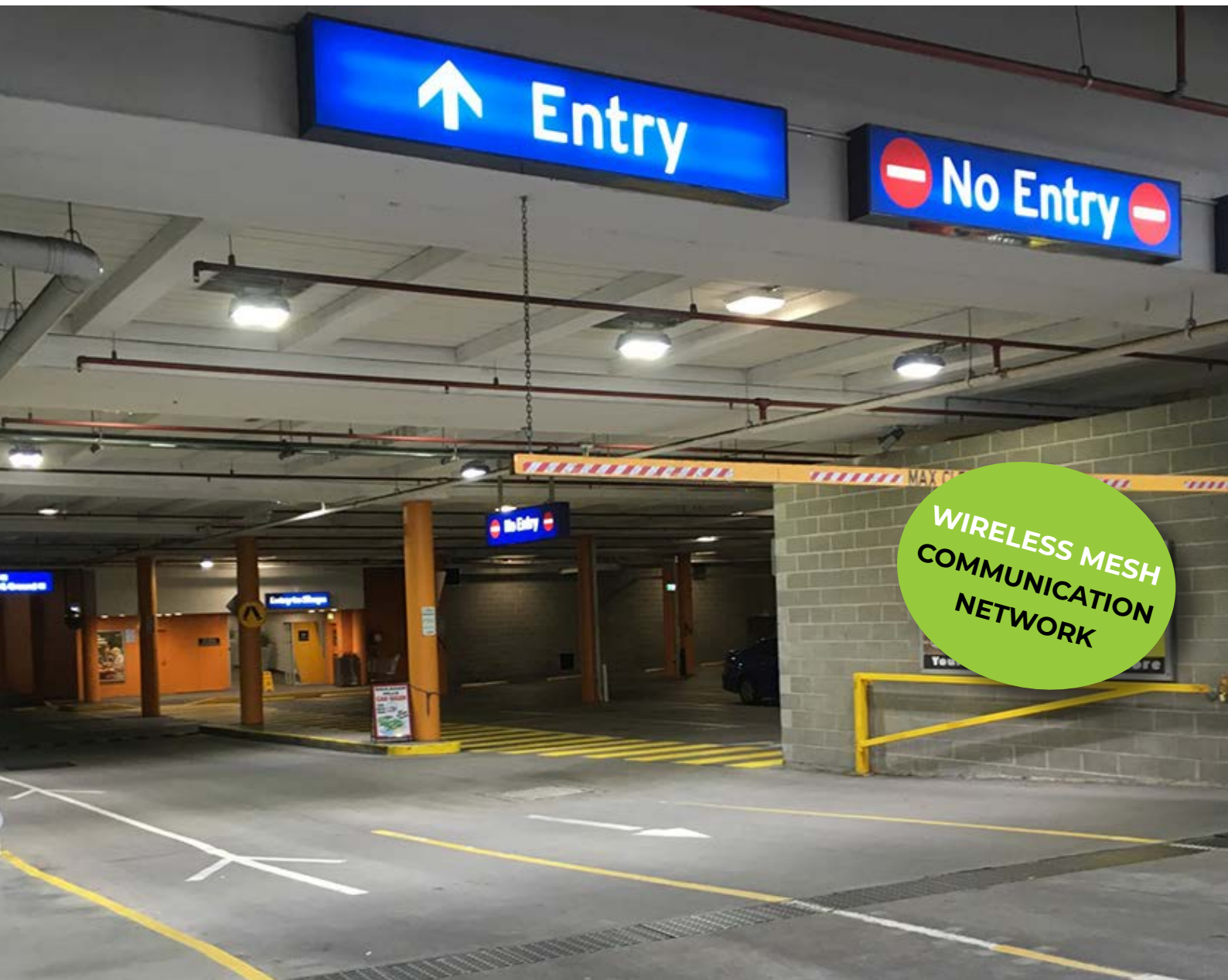

enLighten



Car Park Entrance Lighting Control System (CECS)

Make your car park AS1680 compliant

Can smart technology improve safety?

Car park lighting is often overlooked as a road safety factor, yet critical design failures frequently occur at entrances and busy circulation zones.

When entering a car park, a driver's eye must adjust quickly from the bright daylight conditions to the darker car park environment. This transition can lead to temporary blinding, making it difficult for the driver to react to obstacles or pedestrians.

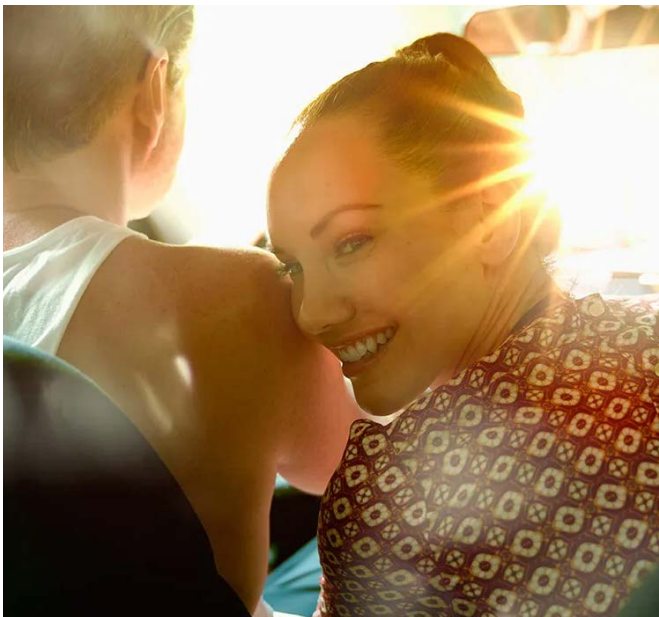

¹ National Road Safety Innovation Fund

² Royal Automobile Association

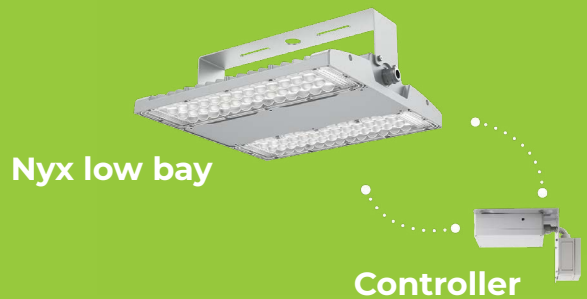

What is our Car Park Entrance Lighting Control System (CECS)?

Several customised low bay lights mounted in the car park entrance, delivering 800 lux during the day and 160 lux at night in line with Australian standards.

A wireless mesh network connects each light, allowing them to communicate with the controller and each other. In the event of damage to the master controller, a built-in safety mode ensures lights default to full output, so the entrance is never under-lit. The luminaires and controller automatically connect when powered up - no additional setup required.

Who is CECS for?

Designer/Specifier	Electrical Contractor	Asset Owner/Operator
<ul style="list-style-type: none"> • Less work: full design is provided for multiple entrance types, guaranteeing compliance to AS 1680. • No risk: proven system over 10 years, installed in hundreds of car parks across Australia. • Full support: all technical materials, layouts and spacing guidance available. • DALI not required 	<ul style="list-style-type: none"> • Simple installation: no control panels, interconnecting wiring or commissioning. Simply mount luminaires and walk away. • Installation support: exact locations for mounting luminaires on the ceiling provided for each project. • Technical support: any questions, we have a technician at the end of a phone to respond. 	<ul style="list-style-type: none"> • Cost-effective solution to deliver compliant car park entrance lighting. • Smart-looking solution: cleaner ceiling lines, reducing clutter from the car park entrance. • Safety a priority: designed to default to full light output should something go wrong.

Australian Standard Requirements

Type of interior or activity	Maintained Illuminance (lux)
Car parks (indoors)	
Entrances:	
(a) During daytime	
- first 15m	800
- next 4m	160
(b) During night-time	
- first 19m	160
Pay booths	160
Loading docks	80
Exits, ramps, circulating roads, pedestrian crossings	40
Normal parking spaces	40

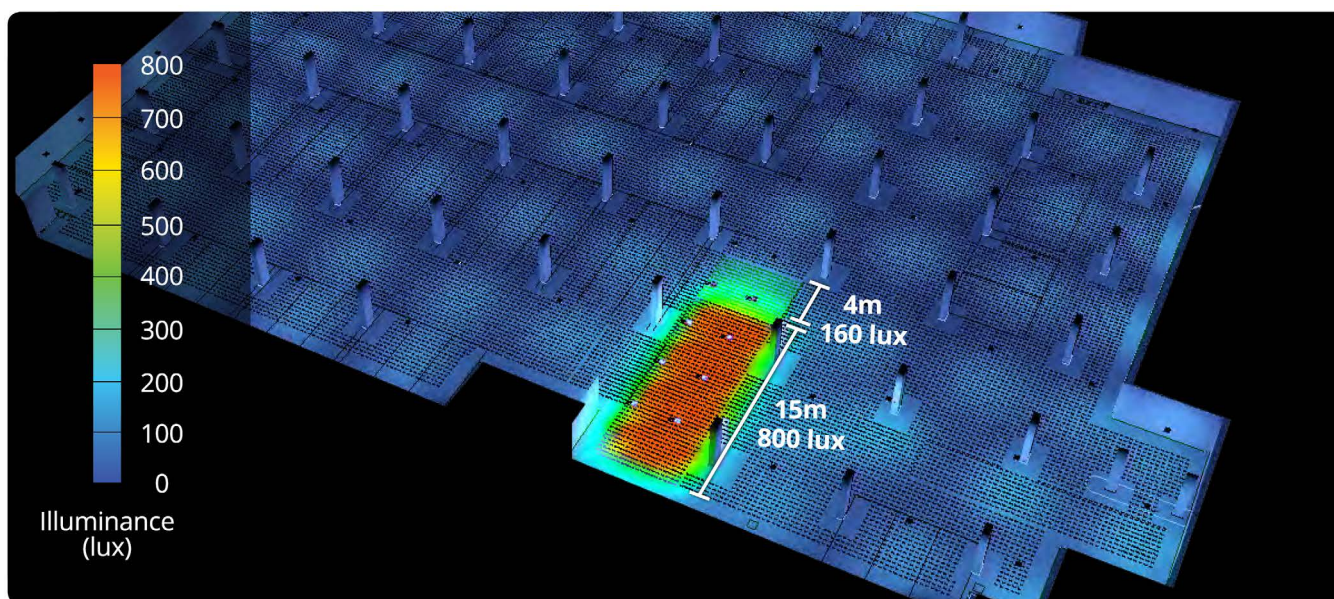

AS 1680
COMPLIANT

PROVEN SINCE 2016 IN HUNDREDS
OF AUSTRALIAN CAR PARKS.
UPGRADED FOR 2026

AUTOMATICALLY ADJUSTS
LIGHTING LEVEL

NO CONTROL PANELS. NO WIRING.
NO COMMISSIONING.
JUST SIMPLE INSTALLATION

Proven in Australian Car Parks Since 2016

Australian Technology Park

The Australian Technology Park boasts over 700 car spaces and 600 plus bicycle spots. The Mirvac Group's vision was to create a world-class innovation hub. Buildings 1 and 2 are using the Car Park Entrance Lighting Control System (CECS) with daylight sensor and RF control transmitter. This helps ensure safe entry into these facilities whilst adhering to the building code.



Chatswood Chase

Chatswood Chase is the premier shopping destination on Sydney's North Shore, boasting over 2,200 car spaces. The Chase values their customers and installed the Car Park Entrance Lighting Control System (CECS) on the B1 Victoria Ave entrance. The CECS has dramatically improved lighting levels.



Rockdale Plaza

Located on the Princess Highway with over 875 car spaces, Rockdale Plaza opened in 1997. This shopping centre has been refurbished in 2018. Two CECS' were installed, each wirelessly communicating via RF waves with a bank of luminaires that automatically adjusts light levels as specified in the Building Code of Australia (800 lux daylight and 160 lux at night for safe entry).



Stockland Baulkham Hills

With an average of 68,000 visitors a week and 6,000 customers using the car park each day and only 831 spaces available. Stockland Baulkham Hills knew the importance of a safe, uninterrupted entry into the car park. As a result, every car park entrance has been fitted with a CECS.

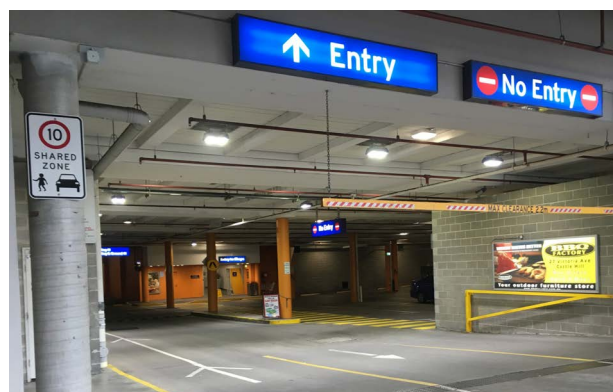

How to select your Car Park Entrance Lighting System

1) Obtain the ceiling height and the width of entrance driveway only

For example, the ceiling height is 2.5m and entrance width is 4m.

2) Use selection tables to determine lights required

Car Park Entrance Product Selection
Single Wide Lane Entry - 4m Wide



Height	2.5m	3m	3.5m	4m	4.5m	5m
Nyx	4 x NYX-840-S1-L	4 x NYX-840-S1-L	4 x NYX-840-S1-M	4 x NYX-840-S1-H	4 x NYX-840-S1-H	4 x NYX-840-AR3-H
Vico 2	1 x VB12-840	2 x VB12-840	2 x VB12-840	2 x VB12-840	2 x VB12-840	2 x VB12-840
CECS Controller	1 x CECS-NYX-T	1 x CECS-NYX-T	1 x CECS-NYX-T	1 x CECS-NYX-T	1 x CECS-NYX-T	1 x CECS-NYX-T

3) Select 1 controller

1 Controller per entrance | Controller Model number: CECS-NYX-T

4) Place an order through your electrical wholesaler

CECS Components List:

- 4 x NYX-840-S1-L
- 1 x VB12-840
- 1 x CECS-NYX-T

5) For detailed installation instructions or if you have any questions, contact enLighten

Visit our [website](#).

Email: sales@enlighten.com.au or **call:** 1800 365 444

MAKE YOUR CAR PARK ENTRY COMPLIANT WITH enLighten *smart control*

Intelligent wireless lighting control system for car parks

NYX

ENGINEERED TO PERFORM

- Extensive operating life at L70 for 130,000hrs
- Superior protection from physical impact
- Slimline profile perfect for car park entries
- Save money by reducing the number of luminaires required

5 YEAR
WARRANTY

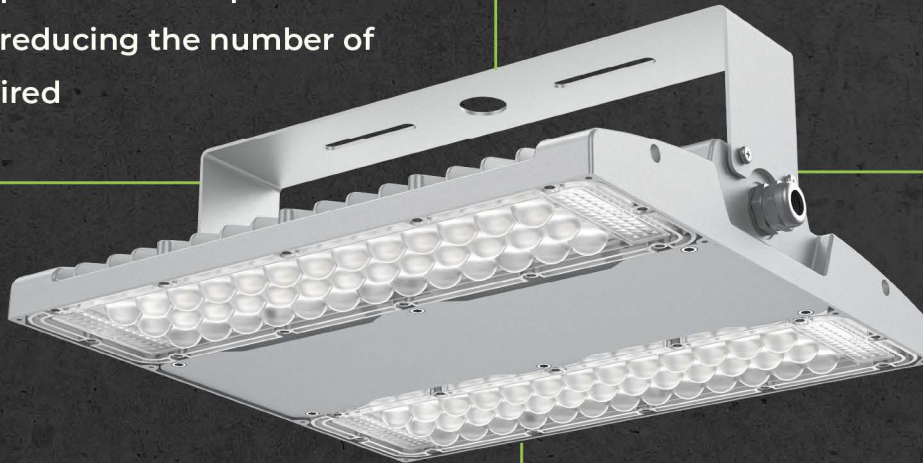

EASY TO INSTALL & MAINTAIN

- Lightweight streamlined design for easy handling and installation
- No complicated wiring and simple set and forget commissioning

CECS CONTROLLER

WIRELESS MESH MODULE



SMART CONTROLS

- Integrated wireless control system for car park entrances
- Self-healing wireless mesh network

TWILIGHT SENSOR

We offer comprehensive car park and pathway solutions

FLOODLIGHT



Noctua

EMERGENCY LIGHTING IN FIRE STAIRS & CAR PARKS



Chamaeleon Eco

WIRELESS CAR PARK ENTRANCE SYSTEM



Nyx



CECS
Controller

CAR PARK LIGHTING



Chamaeleon
Eco



Vico 2

OUTDOOR CAR PARK & PATHWAY LIGHTING



Zorro 2



Yindi

Car Park Entrance Product Selection Guide

Dual Lane Entry - 7m Wide

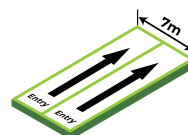

Height	2.5m	3m	3.5m	4m	4.5m	5m
Nyx	8 x NYX-840-S1-L	8 x NYX-840-S1-L	8 x NYX-840-S1-L	6 x NYX-840-S1-H	6 x NYX-840-S1-H	6 x NYX-840-S1-H
Vico 2	2 x VB12-840	2 x VB12-840	3 x VB12-840	3 x VB12-840	3 x VB12-840	3 x VB12-840
CECS Controller	1 x CECS-NYX-T	1 x CECS-NYX-T	1 x CECS-NYX-T	1 x CECS-NYX-T	1 x CECS-NYX-T	1 x CECS-NYX-T

Single Narrow Lane Entry - 3m Wide



Height	2.5m	3m	3.5m	4m	4.5m	5m
Nyx	4 x NYX-840-S1-L	4 x NYX-840-S1-L	4 x NYX-840-S1-M	4 x NYX-840-S1-H	4 x NYX-840-S1-H	4 x NYX-840-AR3-H
Vico 2	1 x VB12-840	1 x VB12-840	1 x VB12-840	1 x VB12-840	1 x VB12-840	1 x VB12-840
CECS Controller	1 x CECS-NYX-T	1 x CECS-NYX-T	1 x CECS-NYX-T	1 x CECS-NYX-T	1 x CECS-NYX-T	1 x CECS-NYX-T

Single Wide Lane Entry - 4m Wide



Height	2.5m	3m	3.5m	4m	4.5m	5m
Nyx	4 x NYX-840-S1-L	4 x NYX-840-S1-L	4 x NYX-840-S1-M	4 x NYX-840-S1-H	4 x NYX-840-S1-H	4 x NYX-840-AR3-H
Vico 2	1 x VB12-840	2 x VB12-840	2 x VB12-840	2 x VB12-840	2 x VB12-840	2 x VB12-840
CECS Controller	1 x CECS-NYX-T	1 x CECS-NYX-T	1 x CECS-NYX-T	1 x CECS-NYX-T	1 x CECS-NYX-T	1 x CECS-NYX-T

Combination Entry & Exit - 7m Wide

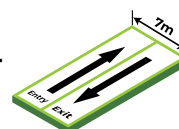

Height	2.5m	3m	3.5m	4m	4.5m	5m
Nyx	4 x NYX-840-S1-L	4 x NYX-840-S1-L	4 x NYX-840-S1-M	4 x NYX-840-S1-H	4 x NYX-840-S1-H	4 x NYX-840-AR3-H
Vico 2	6 x VB12-840	8 x VB12-840	8 x VB12-840	8 x VB12-840	8 x VB12-840	8 x VB12-840
CECS Controller	1 x CECS-NYX-T	1 x CECS-NYX-T	1 x CECS-NYX-T	1 x CECS-NYX-T	1 x CECS-NYX-T	1 x CECS-NYX-T

Nyx CECS Datasheet

PRODUCT RANGE

Model #	Wattage (W)	Luminous Flux (lm)	Weight (kg)
NYX-840-S1-L	100	18500	4
NYX-840-S1-M	120	22100	
NYX-840-S1-H	150	27750	
NYX-840-AR3-H	150	27750	

TECHNICAL INFORMATION

Optical

Light source	LED
Lumen output	18500 - 27750 lumens
CRI	Ra>80
CCT	4000K
Luminaire efficacy	185 lm/W
Optics	S1, AR3

Electrical

Power consumption	100W-150W
Operating frequency	50/60 Hz
Operating voltage range	220 – 240V AC
Power factor	>0.95
Driver	Sosen

Environmental

IP rating	IP65
Impact rating	IK10
Net weight	4kg
Ambient temperature range	-30°C to +50°C
Material composition (body)	Aluminium alloy
Material composition (diffuser)	Polycarbonate lens
Expected lifespan	>130,000hrs @L70 >81,000hrs @L80

Warranty* 5 years

Data subject to change without notice
* Refer to warranty policy

DIMENSIONS

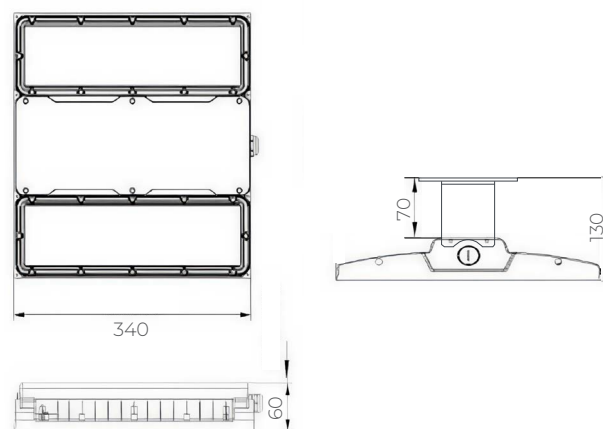

PHOTOMETRICS

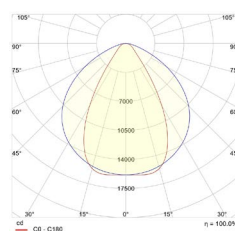

AR3

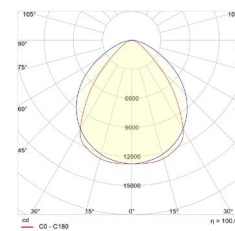

S1